

# SAW Bandpass Filter F9023



## Features

- RF bandpass filter
- High attenuation
- Usable bandwidth 35MHz
- No matching 50Ω single-ended operation
- Ceramic Surface Mounted Device (SMD) Package

## Package Dimensions

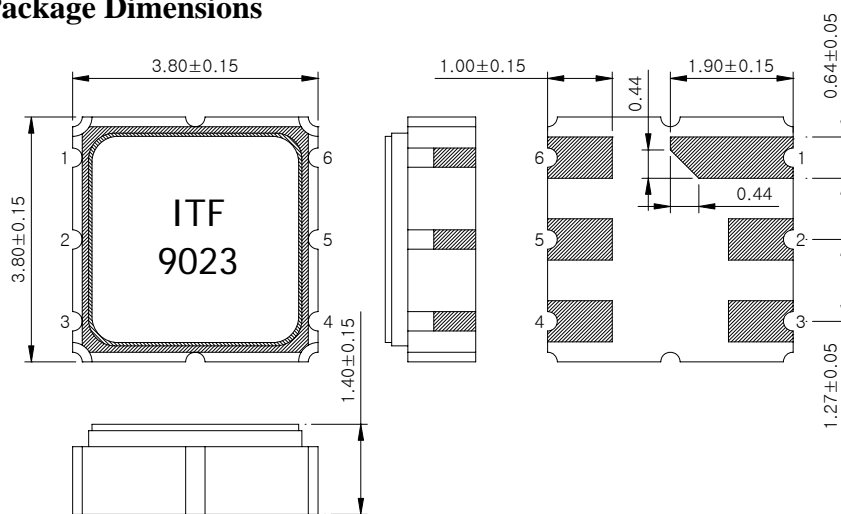

Dimensions shown are nominal in millimeters

Body :  $Al_2O_3$  Ceramic

Lid : Kovar, Ni Plated

Terminations : Au plating 0.3 ~ 1.0 um, Over a 1.27 ~ 8.89 um Ni Plating

Pin Configuration	
2	Input
5	Output
1, 3, 4, 6	Case ground

## Maximum Ratings

Parameter	Unit	Minimum	Typical	Maximum
Operating Temperature Range	°C	-10	25	60
Storage Temperature Range	°C	-40	-	85
Power Handling Capability	dBm	-	-	-

Electrostatics Sensitive Device (ESD)

	<b>ITF Co., Ltd.</b> 102-901, Bucheon Technopark 364, Samjeong-Dong, Ojeong-Gu, Bucheon-City, Gyeonggi-Do, Korea 421-809	Part No.	F9023	
		Rev. Date	2004-11-01	
		Rev.	DR3006-PS02	1/7

# SAW Bandpass Filter F9023



## Preliminary specifications

$F_c = 902.5\text{MHz}$

Terminating source impedance :  $50\Omega$

Terminating load impedance :  $50\Omega$

		Minimum	Typical	Maximum
Center Frequency ( $F_c$ )	MHz	-	902.5	-
Insertion Loss ( $F_c \pm 17.5$ MHz)	dB	-	3.5	4.5
Amplitude Ripple ( $F_c \pm 17.5$ MHz)	dB	-	1.5	2.0
Absolute Group Delay at $F_c$	nsec	-	35	-
Group Delay Variation ( $F_c \pm 17.5$ MHz)	nsec	-	15	-
VSWR ( $F_c \pm 17.5$ MHz)		-	1.5	2.5
Relative Attenuation ... ~ $F_c - 80$ MHz $F_c + 120$ MHz ~ ...	dB	45 45	50 50	-
Temperature Coefficient of Frequency	ppm/ $^{\circ}\text{C}$	-	-80	-

### Notes :

- 1) All specifications are based on the matching schematic shown below, measured by Agilent Network analyzer and full 2 port calibration.
- 2) Electrical margin has been built into the design to account for the variations due to temperature drift and manufacturing tolerances
- 3) All attenuation measurements are measured relative to insertion loss

	<b>ITF Co., Ltd.</b> 102-901, Bucheon Technopark 364, Samjeong-Dong, Ojeong-Gu, Bucheon-City, Gyeonggi-Do, Korea 421-809	Part No.	F9023	
		Rev. Date	2004-11-01	
		Rev.	DR3006-PS02	2/7

# SAW Bandpass Filter F9023



## Matching Schematic

( Actual matching values may vary due to PCB layout and parasitics )



## Marking Configuration

ITF<sup>1)</sup>  
9023<sup>2)</sup>

1) Manufacturer name

2) Marking Number

\* Ink or Laser Marking available

	<b>ITF Co., Ltd.</b> 102-901, Bucheon Technopark 364, Samjeong-Dong, Ojeong-Gu, Bucheon-City, Gyeonggi-Do, Korea 421-809	Part No.	F9023	
		Rev. Date	2004-11-01	
		Rev.	DR3006-PS02	3/7

# SAW Bandpass Filter F9023



## Typical Performance ( at 25°C )

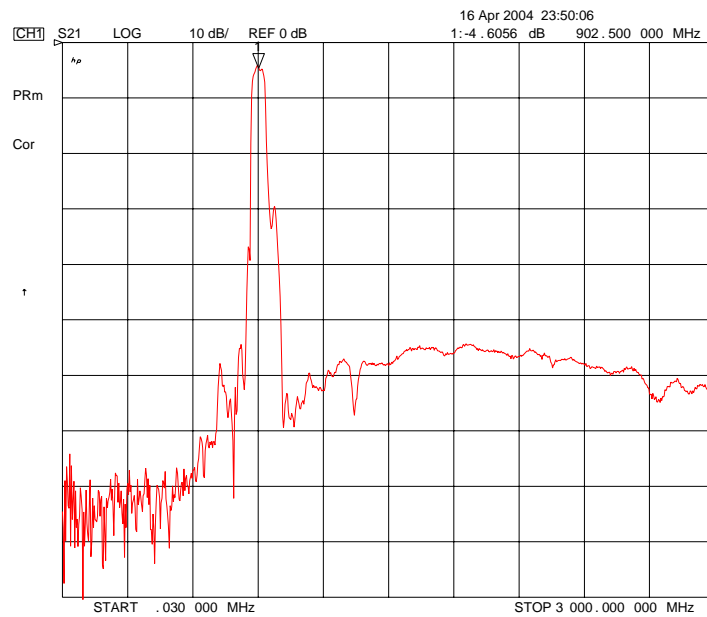
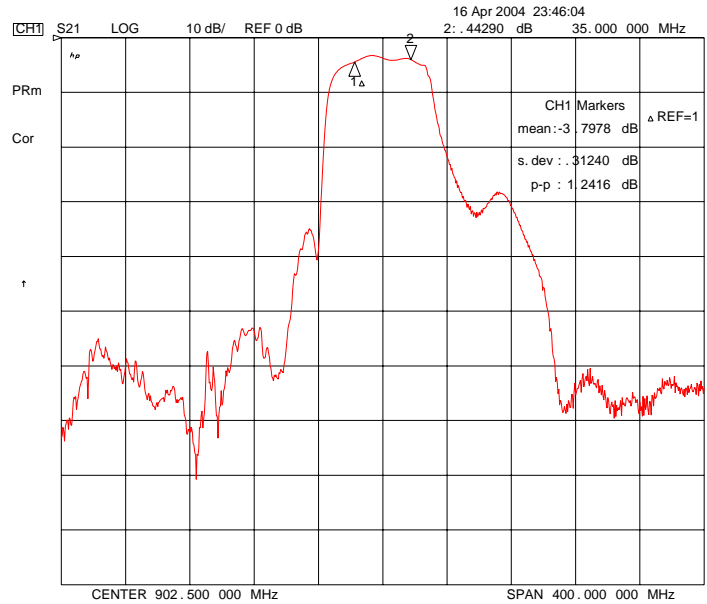

	<b>ITF Co., Ltd.</b> 102-901, Bucheon Technopark 364, Samjeong-Dong, Ojeong-Gu, Bucheon-City, Gyeonggi-Do, Korea 421-809	Part No.	F9023	
		Rev. Date	2004-11-01	
		Rev.	DR3006-PS02	4/7

# SAW Bandpass Filter F9023



## Input / Output VSWR Charts

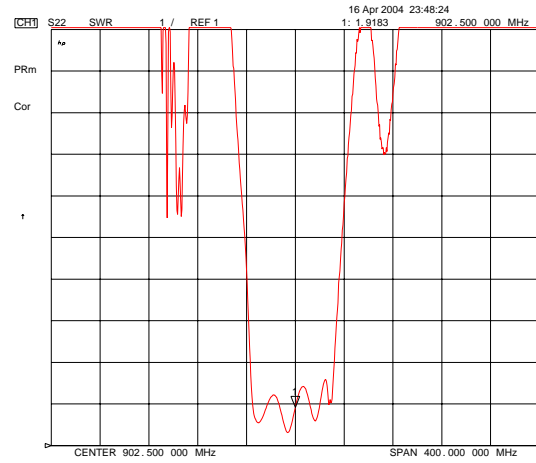
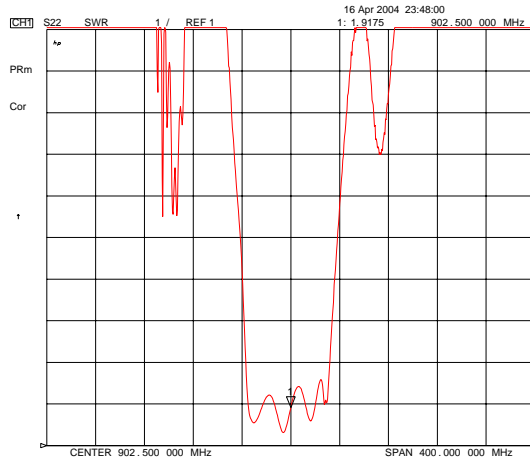

## Input / Output Smith Charts

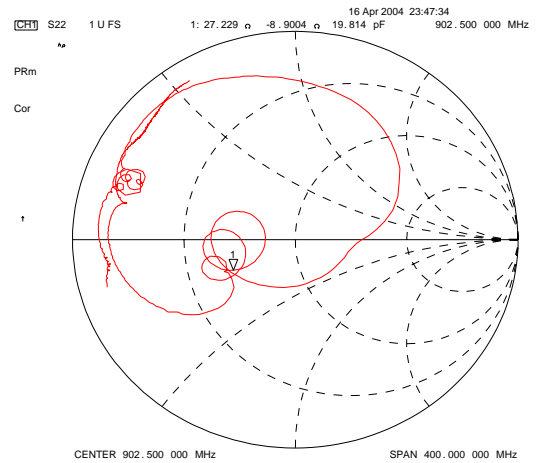
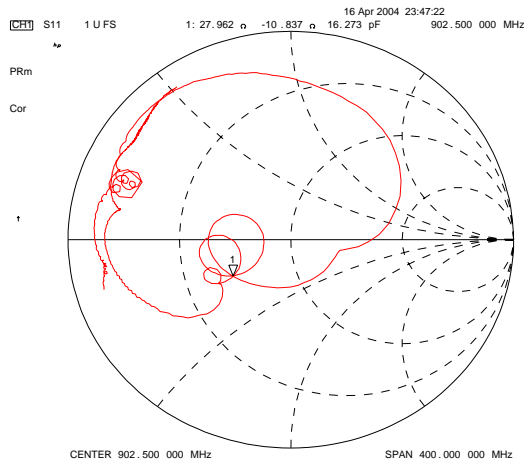

	<b>ITF Co., Ltd.</b> 102-901, Bucheon Technopark 364, Samjeong-Dong, Ojeong-Gu, Bucheon-City, Gyeonggi-Do, Korea 421-809	Part No.	F9023	
		Rev. Date	2004-11-01	
		Rev.	DR3006-PS02	5/7

# SAW Bandpass Filter F9023



## Packing Specification

1. Reeling Quantity : 1000 pcs / reel
2. Taping Structure : The tape shall be wound around the reel in the direction shown below.

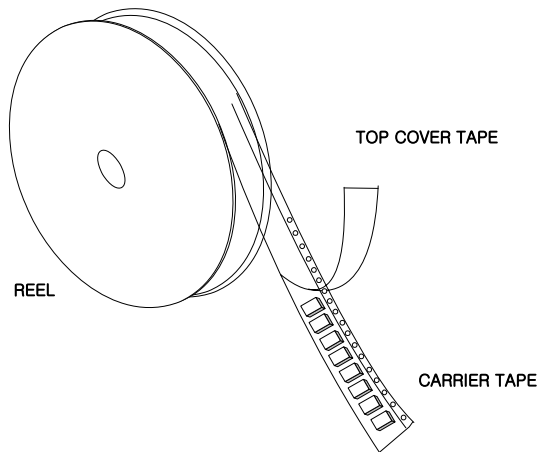

## Tape Specification

1. Leader part and vacant position specification

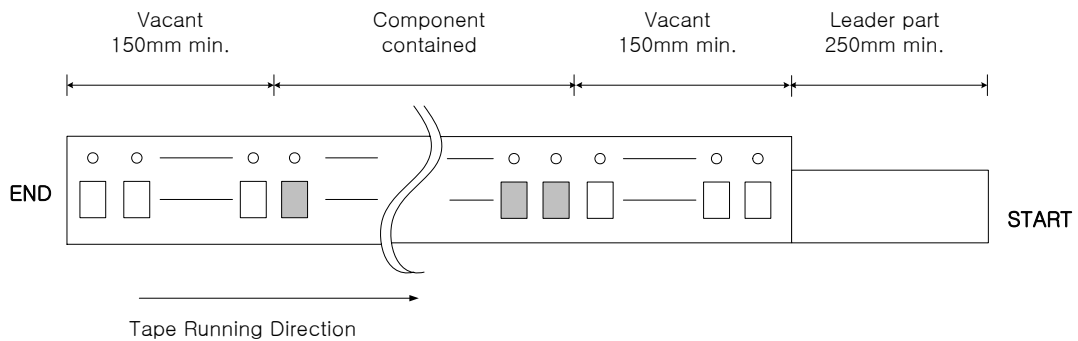

2. Tensile strength of carrier tape

4.4N/mm width

3. Top cover tape adhesion

- 1) pull off angle : 0~15°
- 2) speed : 300mm/min
- 3) force : 20~70g

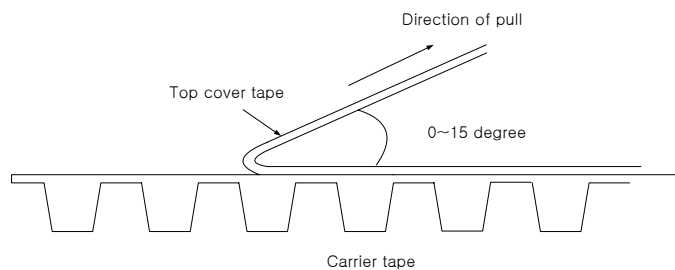

	<b>ITF Co., Ltd.</b> 102-901, Bucheon Technopark 364, Samjeong-Dong, Ojeong-Gu, Bucheon-City, Gyeonggi-Do, Korea 421-809	Part No.	F9023	
		Rev. Date	2004-11-01	
		Rev.	DR3006-PS02	6/7

